

# STURDILITE

## Selection and Ordering Guide

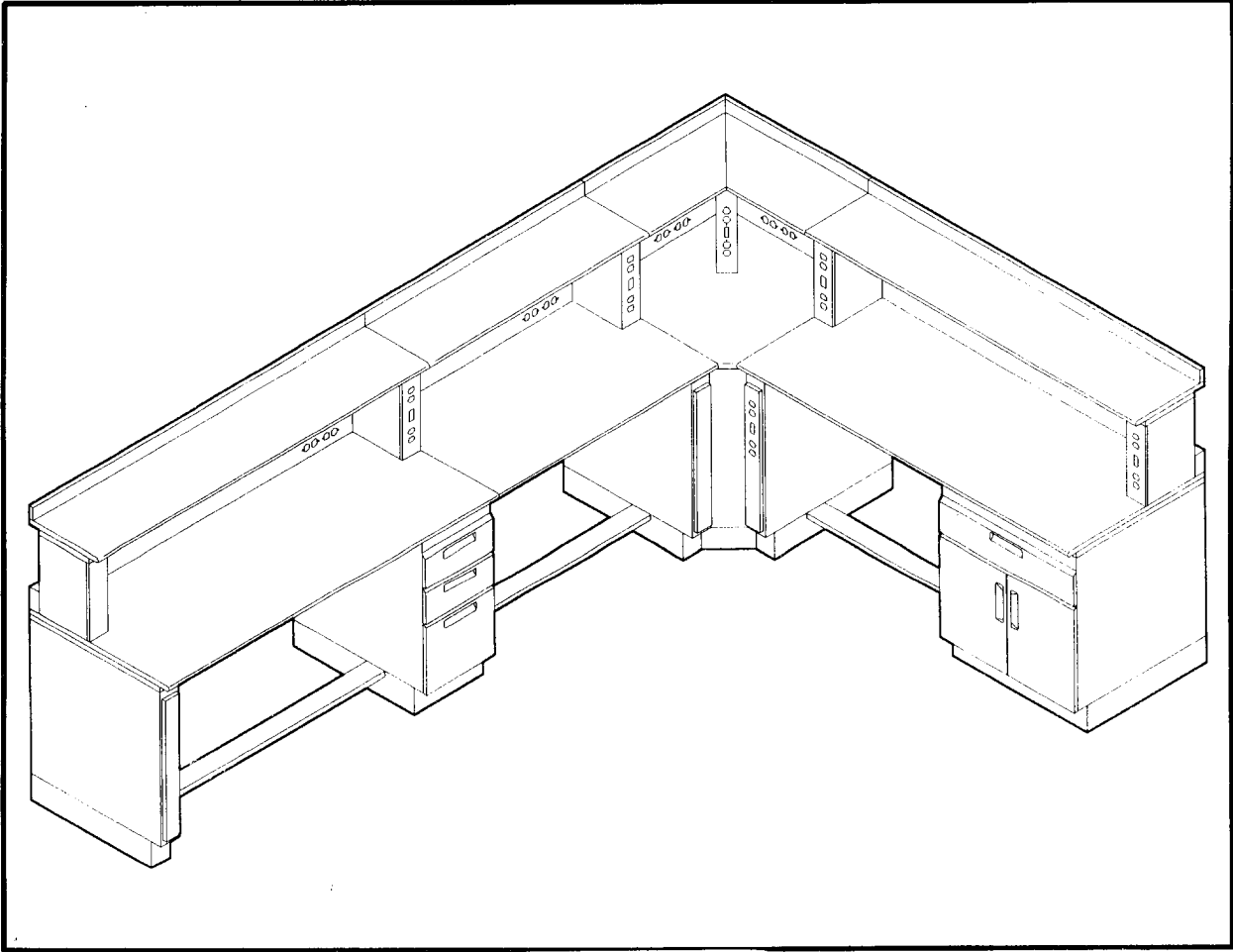

Effective August 1, 1994



K E W A U N E E

# **KEWAUNEE SCIENTIFIC CORPORATION**

---

**SERVING THE TECHNICAL WORKPLACE SINCE 1906**

Kewaunee offers a complete line of products to make your technical environment comfortable and productive. Our "systems approach" to layout planning provides you with the expertise of our workstation professionals to design a technical workplace built to meet your specifications.

## **STURDILITE™ TECHNICAL WORKSTATIONS**

Sturdilite Technical Workstations are designed for today's professional work environment. Constructed of heavy-duty materials and engineered to provide the optimum use of your work area, Sturdilite will help you attain maximum productivity from your space and personnel.

### **TABLE OF CONTENTS**

<b>Product Vocabulary</b> .....	<b>2</b>
<b>How to Select, Specify and Order</b> .....	<b>3</b>
<b>Worksurfaces</b> .....	<b>4-7</b>
<b>Worksurface Backsplashes</b> .....	<b>8-10</b>
<b>Pedestals</b> .....	<b>11-21</b>
<b>Shelves</b> .....	<b>22-24</b>
<b>Shelf Backsplashes</b> .....	<b>25</b>
<b>Shelf Risers</b> .....	<b>26</b>
<b>Footrests</b> .....	<b>27</b>
<b>Lighting</b> .....	<b>28</b>
<b>ESD Options</b> .....	<b>29</b>

# PRODUCT VOCABULARY

---

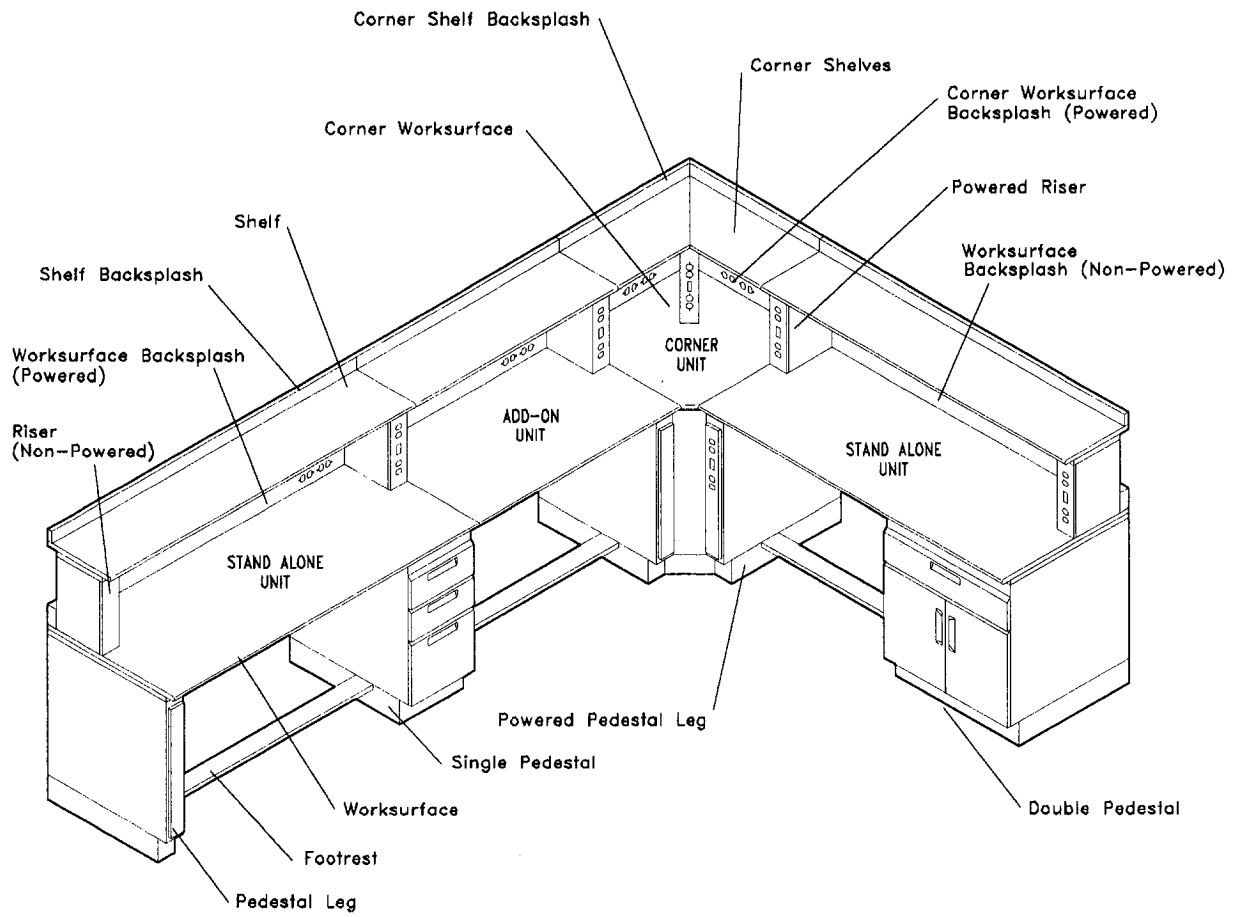

## **HOW TO SELECT, SPECIFY AND ORDER**

---

The following pages employ a step-by-step guide to specify the exact STURDILITE components required to create a workstation designed around your specific needs.

### **TO BEGIN:**

- (1) Measure the allocated space
- (2) Determine personnel requirements
- (3) Indicate features important for operational standards

At any time, contact a Kewaunee representative from our nationwide service network to provide you with assistance in determining your exact workstation requirements.

### **ORDERING A WORKSTATION:**

1. Determine the desired worksurface width: 36", 48", 60", 72", 84" or 96"
2. Choose the desired depth of the worksurface: 30" or 36"
3. Select a worksurface type: Standard laminate, ESD laminate or Maple top
4. Specify the worksurface color with a suffix to the product number
5. Choose risers and shelf
6. Determine storage requirements and type of pedestals needed
7. Specify the painted steel color(s) for the pedestal casing and drawer/riser fronts:  

Sand Tan, Dove Gray, Fashion Blue, Mocha, Metallic Gray,  
Ice Blue, Navy, Teal, Flint Gray, Burgundy, Black and White  
Customized paint colors may be specified, consult your Kewaunee Representative for details
8. Select workstation accessories (backsplashes, lights, footrests.....etc.)
9. Record the product number and quantity of each item on the quotation request/purchase order

# WORKSURFACES

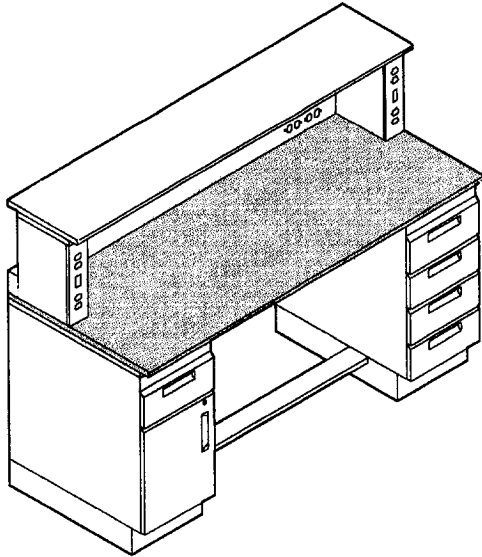

## Front Radius Edge Worksurfaces

Worksurfaces are composed of high pressure plastic laminate and include a tubular steel support frame and modesty panel.

ESD Worksurfaces are composed of electrostatic dissipative (ESD) plastic laminate. A grounding kit is provided.

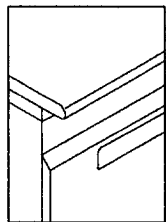

Front Radius Edge  
(1" Thick)

Depth	Width	Product Number		Approx. Weight
		Standard*	ESD*	
30"	36"	43036D_	43036DE_	52
	48"	43048D_	43048DE_	61
	60"	43060D_	43060DE_	74
	72"	43072D_	43072DE_	87
	84"	43084D_	43084DE_	99
	96"	43096D_	43096DE_	112
36"	36"	43636D_	43636DE_	63
	48"	43648D_	43648DE_	72
	60"	43660D_	43660DE_	87
	72"	43672D_	43672DE_	102
	84"	43684D_	43684DE_	111
	96"	43696D_	43696DE_	120

Specify color preference with a suffix to the product number:

\*Worksurface Colors: F - Natural Almond, FG - Dove Gray

Note: A slight variance in color exists between standard and ESD worksurfaces

## WORKSURFACES - MAPLE

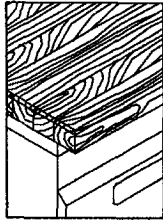

Maple (1 3/4" Thick)

### Maple Worksurfaces

Maple Worksurfaces are constructed of cured maple hardwood and finished with a non-glare, clear lacquer coating. A modesty panel is included and an optional tubular steel frame is available for corner and bridging capabilities. Use of maple increases the overall height of sit-down and technical height workstations 3/4".

Depth	Width	Product Number		Approx. Weight
		With Frame	Without Frame	
30"	36"	M3036F	N/A	62
	48"	M3048F	M3048N	83
	60"	M3060F	M3060N	100
	72"	M3072F	M3072N	87
	84"	M3084F	M3084N	99
	96"	M3096F	M3096N	112
36"	36"	M3636F	N/A	72
	48"	M3648F	M3648N	96
	60"	M3660F	M3660N	117
	72"	M3672F	M3672N	138
	84"	M3684F	M3684N	157
	96"	M3696F	M3696N	175

## WORKSURFACES - BRIDGE

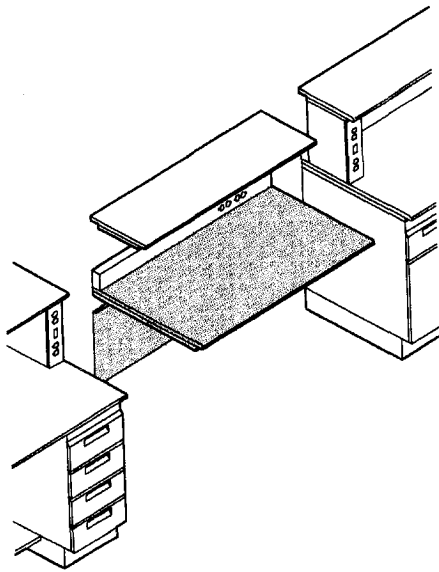

Bridge Worksurfaces can be utilized to economically convert empty space between workstations into a usable work area. They attach directly to the frames of the two adjacent workstations.

### Front Radius Edge Bridge Worksurfaces

Bridge Worksurfaces are composed of high pressure plastic laminate and include a tubular steel support frame and modesty panel.

ESD Bridge Worksurfaces are composed of electrostatic dissipative (ESD) plastic laminate. A grounding kit is provided.

Depth	Width	Product Number		Approx. Weight
		Standard*	ESD*	
30"	36"	43036D_	43036DE_	52
	48"	43048D_	43048DE_	61
	60"	43060D_	43060DE_	74
36"	36"	43636D_	43636DE_	63
	48"	43648D_	43648DE_	72
	60"	43660D_	43660DE_	87

Specify color preference with a suffix to the product number:  
 \*Worksurface Colors: F - Natural Almond, FG - Dove Gray  
 Note: A slight variance in color exists between standard and ESD worksurfaces

### Maple Bridge Worksurfaces

Maple Bridge Worksurfaces are constructed of cured maple hardwood and finished with a non-glare, clear lacquer coating. A modesty panel and tubular steel frame is included. Use of maple raises the overall height of sit-down and technical height workstations  $\frac{3}{4}$ ".

Depth	Width	Product Number	Approx.
			Weight
30"	36"	M3036F	62
	48"	M3048F	83
	60"	M3060F	100
36"	36"	M3636F	72
	48"	M3648F	96
	60"	M3660F	117

# WORKSURFACES - CORNER

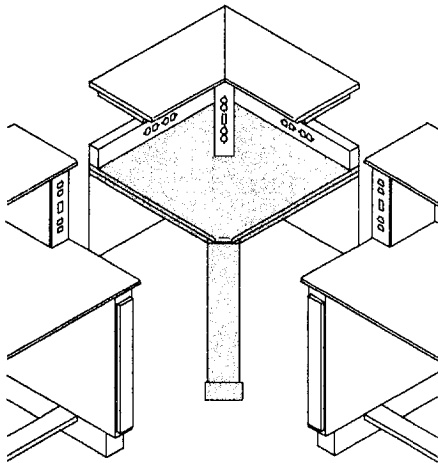

Corner Worksurfaces attach directly to the frames of two adjacent workstations, making the most out of valuable floor space.

## Front Radius Edge Corner Worksurfaces

Corner Worksurfaces are composed of high pressure plastic laminate, and include a tubular steel frame, support leg, and facia filler.

ESD Corner Worksurfaces are composed of electrostatic dissipative (ESD) plastic laminate. A grounding kit is included.

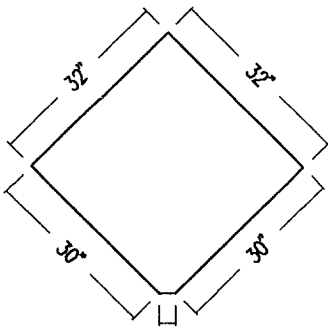

2 3/4"

Corner Worksurface (30" Depth)

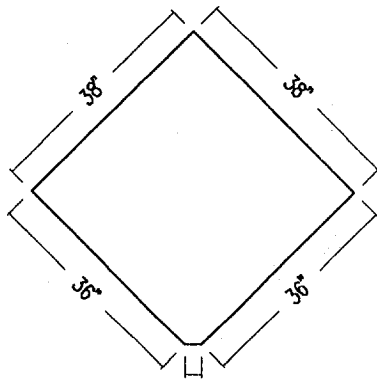

2 3/4"

Corner Worksurface (36" Depth)

Workstation Depth	Height	Product Number		Approx. Weight
		Standard*	ESD*	
30"	Technical	308430_	308630_	152
	Sit-Down	308330_	308530_	152
36"	Technical	308436_	308636_	166
	Sit-Down	308336_	308536_	166

Specify color preference with a suffix to the product number:

\*Worksurface Colors: **A** - Natural Almond, **AG** - Dove Gray

Note: A slight variance in color exists between standard and ESD worksurfaces

## Maple Corner Worksurfaces

Maple Corner Worksurfaces are constructed of cured maple hardwood and finished with a non-glare, clear lacquer coating. A tubular steel frame, support leg and facia filler are included.

Workstation Depth	Height	Product Number	Approx. Weight
30"	Technical	309430A	165
	Sit-Down	309330A	165
36"	Technical	309436A	186
	Sit-Down	309336A	186

## Corner Modesty Panels

Product Number	Approx. Weight
308219	25

# WORKSURFACE BACKSPLASHES

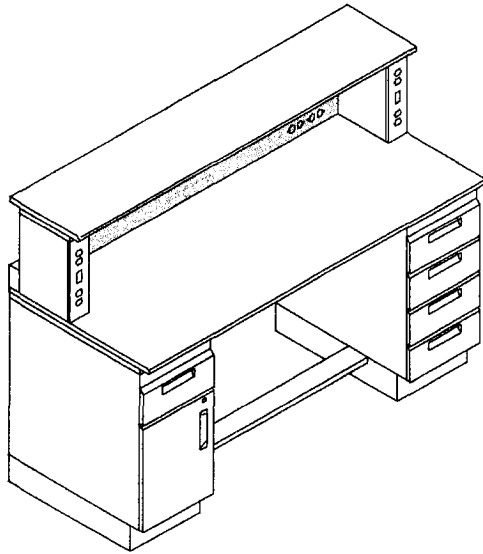

Worksurface Backsplashes are constructed of 20 gauge steel. Powered Worksurface Backsplashes include grounded receptacles, on/off switch with circuit breaker, and a 10 ft. power cord.

## Powered Worksurface Backsplashes

Type	Width	Product Number		Approx. Weight
		15 AMP	20 AMP	
4 Outlets	36"	4036154	4036204	8
	48"	4048154	4048204	10
	60"	4060154	4060204	12
	72"	4072154	4072204	14
	84"	4084154	4084204	16
	96"	4096154	4096204	18
8 Outlets	36"	4036158	4036208	8
	48"	4048158	4048208	10
	60"	4060158	4060208	12
	72"	4072158	4072208	14
	84"	4084158	4084208	16
	96"	4096158	4096208	18

## Non-Powered Worksurface Backsplashes

Type	Width	Product Number	Approx. Weight
Non-Powered	36"	4036000	7
	48"	4048000	9
	60"	4060000	11
	72"	4072000	13
	84"	4084000	15
	96"	4096000	17

## WORKSURFACE BACKSPLASHES - ESD

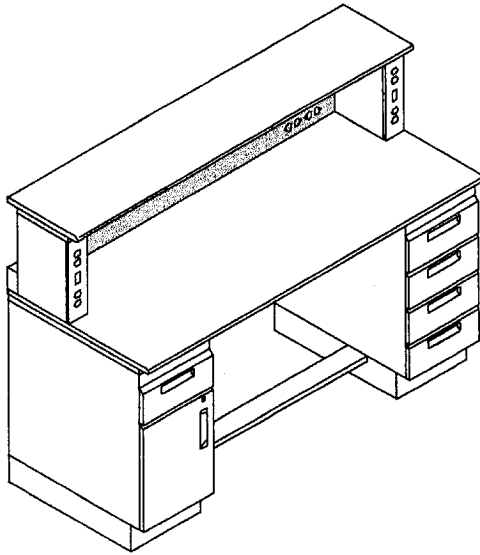

ESD Worksurface Backsplashes are constructed of 20 gauge steel and feature dielectric insulation. Powered ESD Worksurface Backsplashes include grounded receptacles, on/off switch with circuit breaker and a 10 ft. power cord.

### Powered ESD Worksurface Backsplashes

Type	Width	Product Number		Approx. Weight
		15 AMP	20 AMP	
4 Outlets	36"	4036154E	4036204E	8
	48"	4048154E	4048204E	10
	60"	4060154E	4060204E	12
	72"	4072154E	4072204E	14
	84"	4084154E	4084204E	16
	96"	4096154E	4096204E	18
8 Outlets	36"	4036158E	4036208E	8
	48"	4048158E	4048208E	10
	60"	4060158E	4060208E	12
	72"	4072158E	4072208E	14
	84"	4084158E	4084208E	16
	96"	4096158E	4096208E	18

### Non-Powered ESD Worksurface Backsplashes

Type	Width	Product Number	Approx. Weight
Non-Powered	36"	4036000E	7
	48"	4048000E	9
	60"	4060000E	11
	72"	4072000E	13
	84"	4084000E	15
	96"	4096000E	17

## WORKSURFACE BACKSPLASHES - CORNER

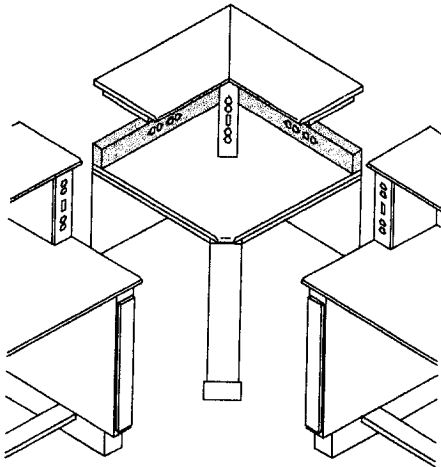

### Powered Corner Worksurface Backsplashes

Powered Corner Worksurface Backsplashes are constructed of 20 gauge steel and include grounded receptacles, on/off switch with circuit breaker, and a 10 ft. power cord.

Type	Corner Depth	Product Number		Approx. Weight
		15 AMP	20 AMP	
8 Outlets	30"	307681	307678	21
	36"	307683	307679	25

### Non-Powered Corner Worksurface Backsplashes

Non-Powered Corner Worksurface Backsplashes are constructed of 20 gauge steel.

Type	Corner Depth	Product Number		Approx. Weight
		Standard	ESD	
Non-Powered	30"	307680	307680E	6
	36"	307682	307682E	7

### ESD Corner Worksurface Backsplashes

ESD Corner Worksurface Backsplashes are constructed of 20 gauge steel and include dielectric insulation, grounded receptacles, on/off switch with circuit breaker, and a 10 ft. power cord.

Type	Corner Depth	Product Number		Approx. Weight
		15 AMP	20 AMP	
8 Outlets	30"	307681E	307678E	22
	36"	307683E	307679E	22

# PEDESTALS

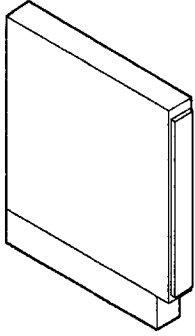

Pedestal Leg

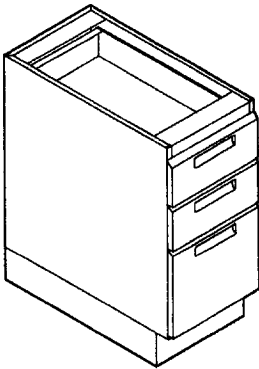

Single Pedestal

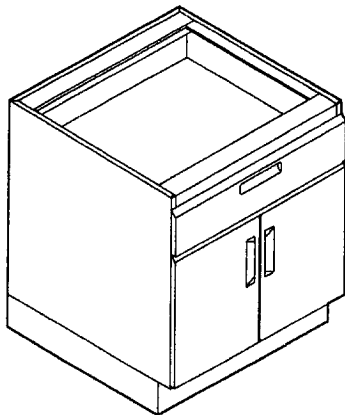

Double Pedestal

Pedestals are constructed of 20 gauge steel and feature non-static generating metal drawer fronts with recessed handle. Drawers are suspended on precision ball-bearing slides. All single and double pedestals have a front cylinder lock.

ESD pedestal drawers are individually grounded to the pedestal case with tangle-resistant, coiled wires.

### How to Specify

Determine the type of pedestal or leg for the left and right sides of the workstation. A center pedestal or (2) double pedestals are necessary for all 96" wide workstations. All pedestals ordered will be "keyed alike" unless other instructions are noted on purchase order.

### SPECIFY KEYING & COLOR INSTRUCTIONS WHEN ORDERING

Pedestal keying options: alike or different

Pedestal casing and drawer front color options:

Sand Tan, Dove Gray, Fashion Blue, Mocha, Metallic Gray, Ice Blue, Navy, Teal, Flint Gray, Burgundy, Black and White

### Pedestal Dimensions

Pedestal Type	Depth	Width	Technical Height	Sit-Down Height
Leg	28 <sup>1</sup> / <sub>8</sub> "	4"	34"	29"
Single	28 <sup>1</sup> / <sub>8</sub> "	15"	34"	29"
Double	28 <sup>1</sup> / <sub>8</sub> "	29 <sup>1</sup> / <sub>8</sub> "	34"	29"

### Inside Drawer Dimensions

Pedestal Type	Drawer	Depth	Width	Height
Single	Personal	25 <sup>3</sup> / <sub>4</sub> "	12 <sup>1</sup> / <sub>4</sub> "	1 <sup>5</sup> / <sub>8</sub> "
	Box			4 <sup>1</sup> / <sub>2</sub> "
	File			9 <sup>1</sup> / <sub>2</sub> "
Double	Personal	25 <sup>3</sup> / <sub>4</sub> "	26 <sup>1</sup> / <sub>2</sub> "	1 <sup>5</sup> / <sub>8</sub> "
	Box			4 <sup>1</sup> / <sub>2</sub> "

# SINGLE PEDESTALS - TECHNICAL HEIGHT

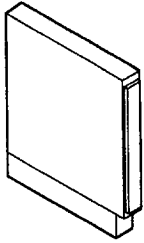

**20NLGA**  
Pedestal Leg  
(42 lbs.)

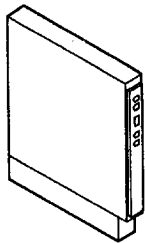

**20NLGPA**  
Powered Pedestal  
Leg  
(44 lbs.)

**20K18A**  
4 Box Drawers  
(105 lbs.)

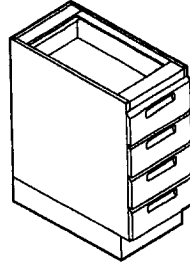

**20K6LA**  
1 Box Drawer  
1 Interior Shelf  
1 LH 19 3/4" Door  
(90 lbs.)

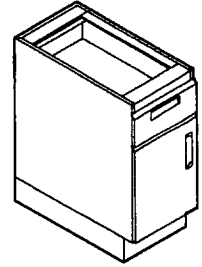

**20K6RA**  
1 Box Drawer  
1 Interior Shelf  
1 RH 19 3/4" Door  
(90 lbs.)

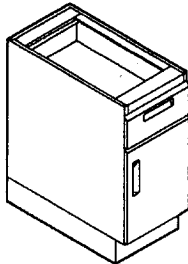

**20K17A**  
2 Box Drawers  
1 File Drawer  
(101 Lbs.)

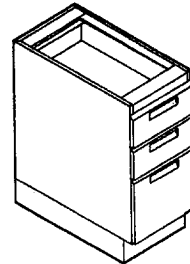

**20K3LA**  
1 LH 26 3/8" Door  
1 Interior Shelf  
(83 lbs.)

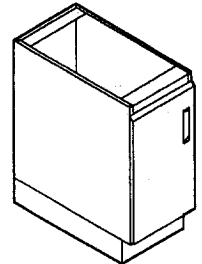

**20K3RA**  
1 RH 26 3/8" Door  
1 Interior Door  
(83 lbs.)

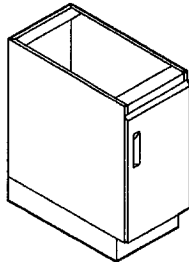

**20K4A**  
2 File Drawers  
(97 lbs.)

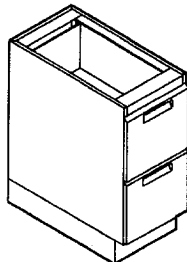

**20K24A**  
4 Personal Drawers  
2 Box Drawers  
(117 lbs.)

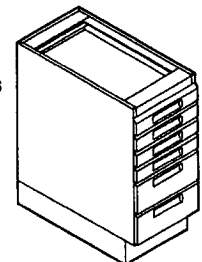

**20K22A**  
2 Personal Drawers  
3 Box Drawers  
(111 lbs.)

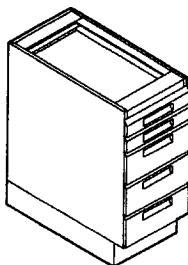

**20K9LA**  
2 Box Drawers  
1 LH 13 1/8" Door  
(98 lbs.)

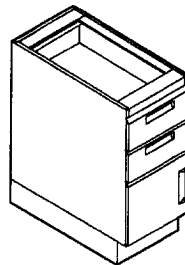

**20K9RA**  
2 Box Drawers  
1 RH 13 1/8" Door  
(98 lbs.)

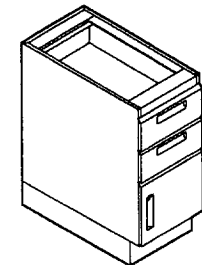

**20K19A**  
2 Personal Drawers  
1 Box Drawer  
1 File Drawer  
(107 lbs.)

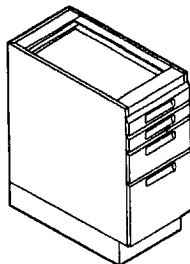

**307400**  
File Drawer  
Separator  
(3 lbs.)

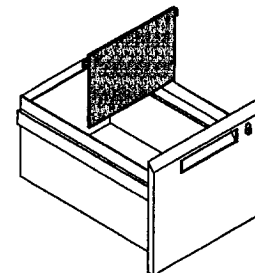

# SINGLE PEDESTALS - TECHNICAL HEIGHT/ESD

**20KELGA**  
ESD Pedestal Leg  
(42 lbs.)

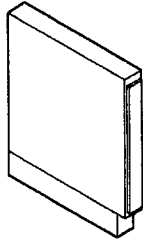

**20KE18A**  
4 Box Drawers  
(105 lbs.)

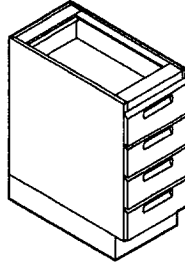

**20KE6LA**  
1 Box Drawer  
1 Interior Shelf  
1 LH 19 3/4" Door  
(90 lbs.)

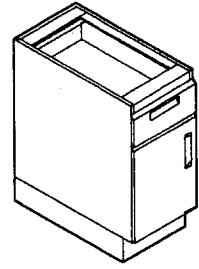

**20KE6RA**  
1 Box Drawer  
1 Interior Shelf  
1 RH 19 3/4" Door  
(90 lbs.)

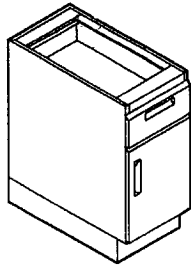

**20KE17A**  
2 Box Drawers  
1 File Drawer  
(101 lbs.)

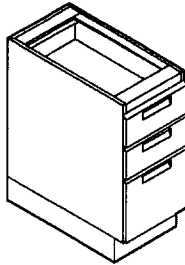

**20KE3LA**  
1 LH 26 3/8 1/4" Door  
1 Interior Shelf  
(83 lbs.)

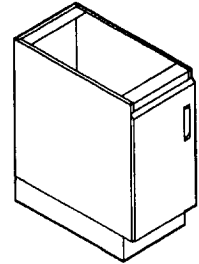

**20KE3RA**  
1 RH 26 3/8 1/4" Door  
1 Interior Shelf  
(83 lbs.)

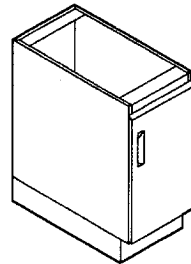

**20KE4A**  
2 File Drawers  
(97 lbs.)

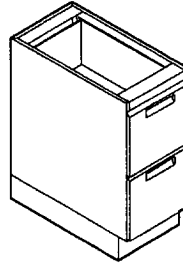

**20KE24A**  
4 Personal Drawers  
2 Box Drawers  
(117 lbs.)

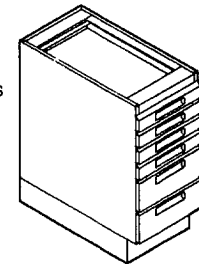

**20KE22A**  
2 Personal Drawers  
3 Box Drawers  
(111 lbs.)

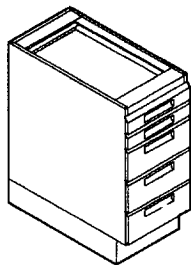

**20KE9LA**  
2 Box Drawers  
1 LH 13 1/8" Door  
(98 lbs.)

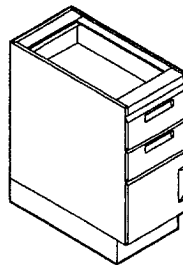

**20KE9RA**  
2 Box Drawers  
1 RH 13 1/8" Door  
(98 lbs.)

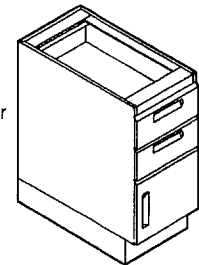

**20KE19A**  
2 Personal Drawers  
1 Box Drawer  
1 File Drawer  
(107 lbs.)

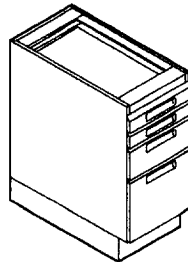

**307400**  
File Drawer  
Separator  
( 3 lbs.)

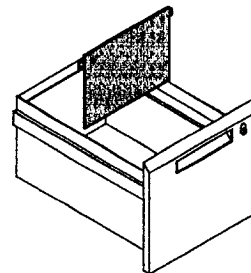

# SINGLE PEDESTALS - TECHNICAL HEIGHT/MOBILE

**M20K18A**  
4 Box Drawers  
(105 lbs.)

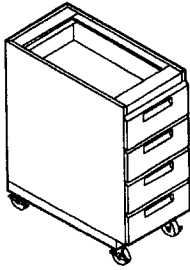

## Mobile Pedestals for Technical Height Workstations

Mobile Pedestals feature swivel, locking casters. They can be used to create a mobile workstation by mounting them under a worksurface. Mobile pedestals can also function as freestanding storage units when a pedestal top is utilized.

**K20K6LA**  
1 Box Drawer  
1 19 3/4" LH Door  
1 Interior Shelf  
(90 lbs.)

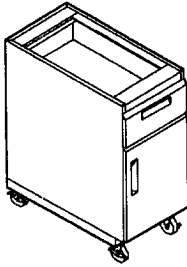

**M20K6RA**  
1 Box Drawer  
1 19 3/4" RH Door  
1 Interior Shelf  
(90 lbs.)

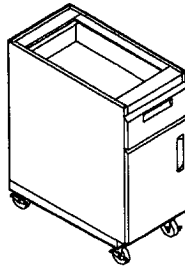

**M20K17A**  
2 Box Drawers  
1 File Drawer  
(97 lbs.)

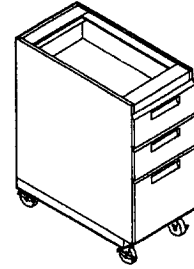

**M20K9LA**  
2 Box Drawers  
1 13 3/4" LH Door  
(98 lbs.)

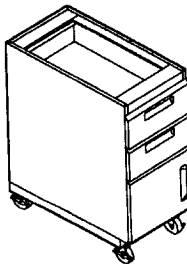

**M20K4A**  
2 File Drawers  
(97 lbs.)

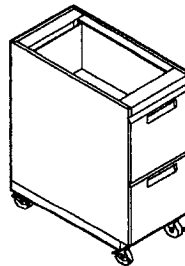

**M20K9RA**  
2 Box Drawers  
1 13 3/4" RH Door  
(98 lbs.)

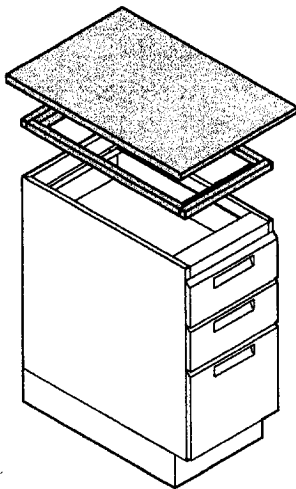
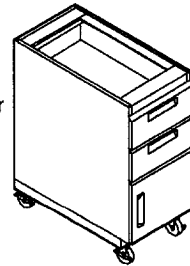

## Single Pedestal Tops with Frame

A Pedestal Top should be specified when the pedestal is used as a mobile or freestanding storage unit. The pedestal top with frame increases the overall height of a technical height mobile pedestal to 36" for laminate tops and 36 3/4" for maple tops. These can also be used as a bridge or add-on unit.

Type	Prod. No.	Appr. Wt.	Depth	Width
Laminate	43020D__	30	30"	20"
Maple	M3020F	37	30"	20"

Specify color preference with a suffix to the product number:  
\*Laminate Colors: F - Almond, FG - Gray

# DOUBLE PEDESTALS - TECHNICAL HEIGHT

---

**40K3A**  
2 26 3/8" Doors  
1 Interior Shelf  
(115 lbs.)

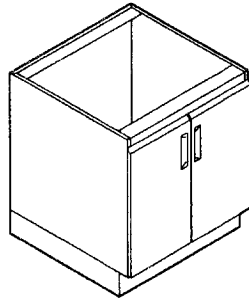

**40K6A**  
1 Box Drawer  
2 19 3/4" Doors  
1 Interior Shelf  
(125 lbs.)

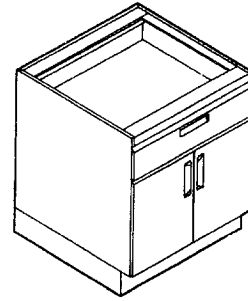

**40K9A**  
2 Box Drawers  
2 13 1/8" Doors  
(137 lbs.)

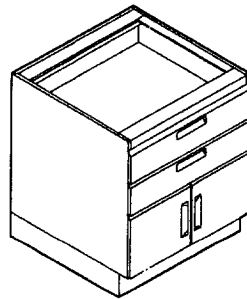

**40K18A**  
4 Box Drawers  
(144 lbs.)

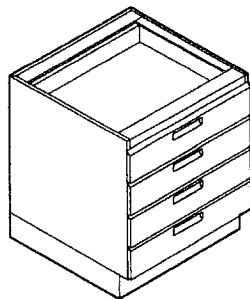

**40K23A**  
2 Personal Drawers  
3 Box Drawers  
(156 lbs.)

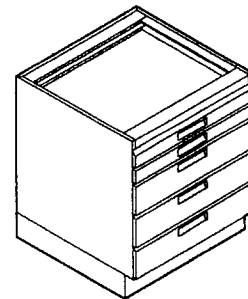

# DOUBLE PEDESTALS - TECHNICAL HEIGHT/ESD

---

**40KE3A**  
2 26 3/8" Doors  
1 Interior Shelf  
(115 lbs.)

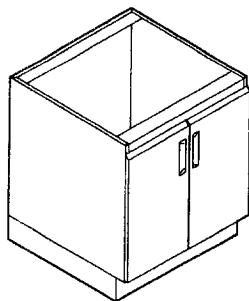

**40KE6A**  
1 Box Drawer  
2 19 3/4" Doors  
1 Interior Shelf  
(125 lbs.)

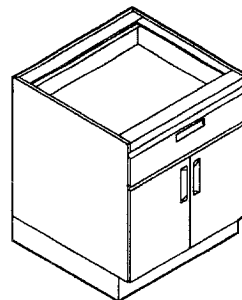

**40KE9A**  
2 Box Drawers  
2 13 1/8" Doors  
(137 lbs.)

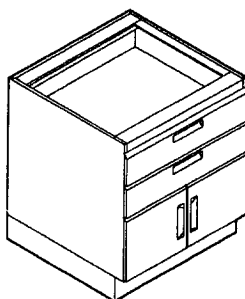

**40KE18A**  
4 Box Drawers  
(144 lbs.)

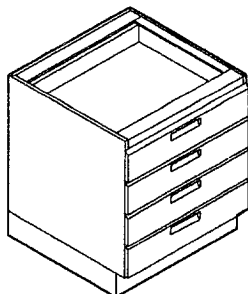

**40KE23A**  
2 Personal Drawers  
3 Box Drawers  
(156 lbs.)

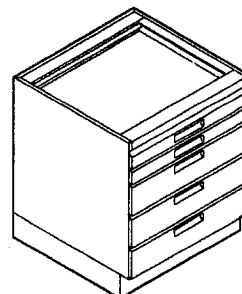

# DOUBLE PEDESTALS - TECHNICAL HEIGHT/MOBILE

## Mobile Pedestals for Technical Height Workstations

Mobile Pedestals feature swivel, locking casters. They can be used to create a mobile workstation by mounting them under a worksurface. Mobile pedestals can also function as freestanding storage units when a pedestal top is utilized.

**M40K3A**  
2 26 3/8" Doors  
1 Interior Shelf  
(115 lbs.)

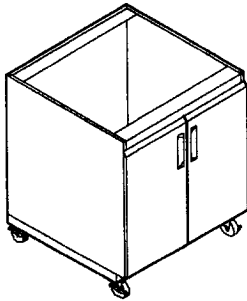

**M40K6A**  
1 Box Drawer  
2 19 3/4" Doors  
1 Interior Shelf  
(125 lbs.)

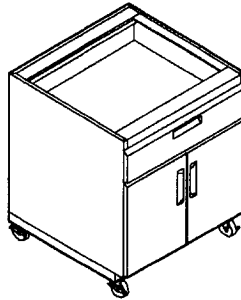

**M40K9A**  
2 Box Drawers  
2 13 1/8" Doors  
(137 lbs.)

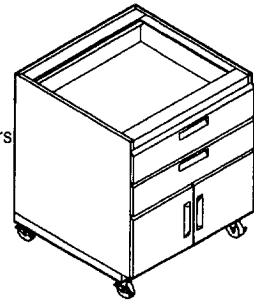

**M40K18A**  
4 Box Drawers  
(144 lbs.)

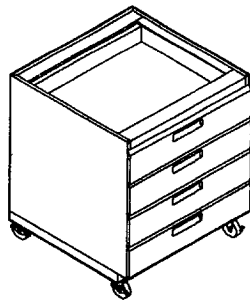

**M40K23A**  
2 Personal Drawers  
3 Box Drawers  
(144 lbs.)

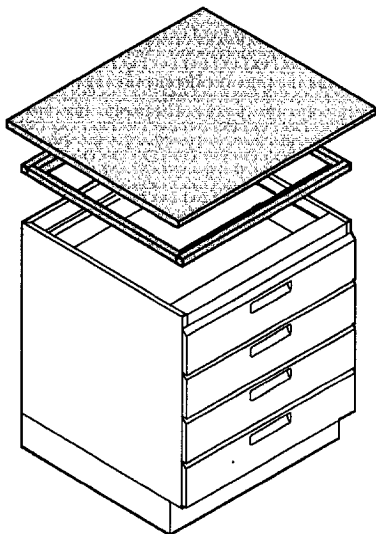
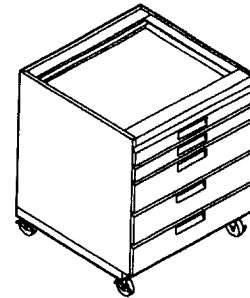

## Double Pedestal Tops with Frame

A Pedestal Top should be specified when the pedestal is used as a mobile or freestanding storage unit. The pedestal top with frame increases the overall height of a technical height mobile pedestal to 36" for laminate tops and 36 3/4" for maple tops. These can also be used as a bridge or add-on unit.

Type	Prod. No.	Appr. Wt.	Depth	Width
Laminate	43034D__	40	30"	34"
Maple	M3034F	55	30"	34"

# SINGLE PEDESTALS - SIT-DOWN HEIGHT

**16NLGA**  
Pedestal Leg  
(37 lbs.)

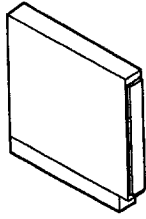

**16NLGPA**  
Powered Pedestal  
Leg  
(37 lbs.)

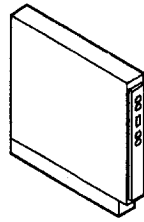

**16K15A**  
3 Personal Drawers  
2 Box Drawers  
(102 lbs.)

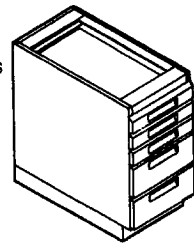

**16K11A**  
1 Personal Drawer  
3 Box Drawers  
(96 lbs.)

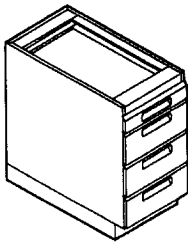

**16K9A**  
1 Personal Drawer  
1 Box Drawer  
1 File Drawer  
(97 lbs.)

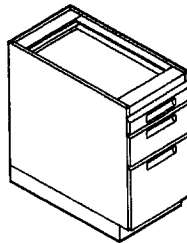

**16K21RA**  
1 Personal Drawer  
1 RH 19 3/4" Door  
1 Interior Shelf  
(74 lbs.)

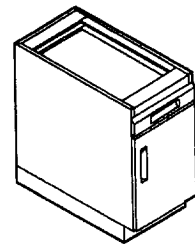

**16K21LA**  
1 Personal Drawer  
1 LH 19 3/4" Door  
1 Interior Shelf  
(74 lbs.)

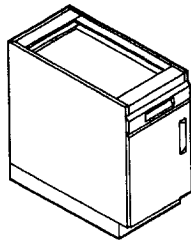

**307400**  
File Drawer  
Separator  
(3 lbs.)

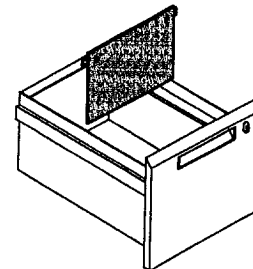

# SINGLE PEDESTALS - SIT-DOWN HEIGHT/ESD

---

**16KELGA**  
ESD Pedestal leg  
(37 lbs.)

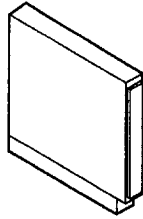

**16KE15A**  
3 Personal Drawers  
2 Box Drawers  
(102 lbs.)

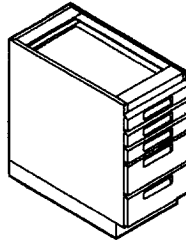

**16KE11A**  
1 Personal Drawer  
3 Box Drawers  
(96 lbs.)

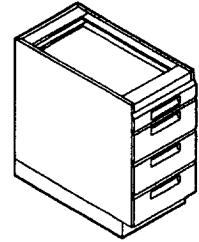

**16KE9A**  
1 Personal Drawer  
1 Box Drawer  
1 File Drawer  
(96 lbs.)

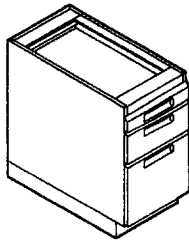

**16KE21RA**  
1 Personal Drawer  
1 RH 19 3/4" Door  
1 Interior Shelf  
(74 lbs.)

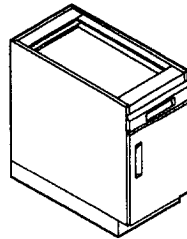

**16KE21LA**  
1 Personal Drawer  
1 LH 19 3/4" Door  
1 Interior Shelf  
(74 lbs.)

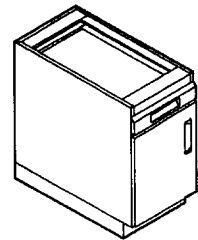

**307400**  
File Drawer  
Separator  
(3 lbs.)

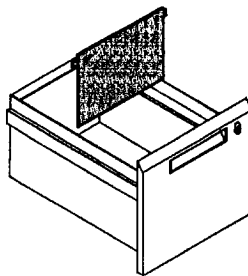

# SINGLE PEDESTALS - SIT-DOWN HEIGHT/MOBILE

## Mobile Pedestals for Sit-Down Height Workstations

Mobile Pedestals feature swivel, locking casters. They can be used to create a mobile workstation by mounting them under a worksurface. Mobile pedestals can also function as freestanding storage units when a pedestal top is utilized.

**M16K11A**  
1 Personal Drawer  
3 Box Drawer  
(102 lbs.)

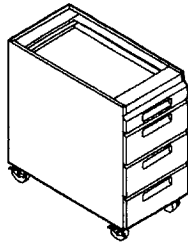

**M16K9A**  
1 Personal Drawer  
1 Box Drawer  
1 File Drawer  
(96 lbs.)

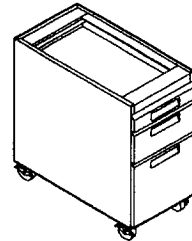

**M16K21LA**  
1 Personal Drawer  
1 19 3/4" Door  
1 Interior Shelf  
(74 lbs.)

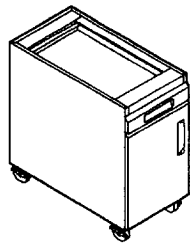

**M16K21RA**  
1 Personal Drawer  
1 19 3/4" Door  
1 Interior Shelf  
(74 lbs.)

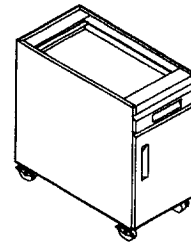

## Single Pedestal Tops with Frame

A Pedestal Top should be specified when the pedestal is used as a mobile or freestanding storage unit. The pedestal top with frame increases the overall height of a technical height mobile pedestal to 36" for laminate tops and 36 3/4" for maple tops. These can also be used as a bridge or add-on unit.

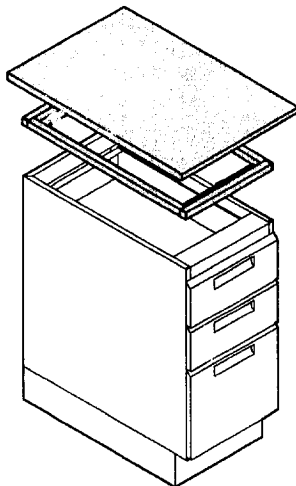

Type	Prod. No.	Appr. Wt.	Depth	Width
Laminate	43020D_ _	30	30"	20"
Maple	M3020F	37	30"	20"

Specify color preference with a suffix to the product number:  
\*Laminate Colors: F - Almond, FG - Gray

## SINK PEDESTALS - TECHNICAL HEIGHT

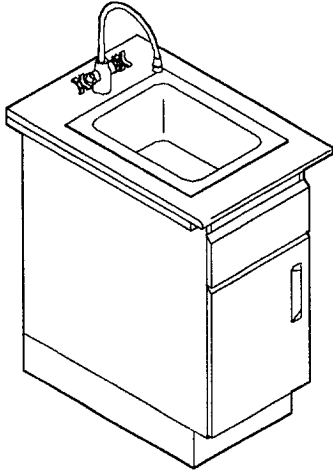

Sink pedestals are stand alone units. Bridge Worksurfaces can be connected to the sink pedestal to construct a complete workstation. Sit-down height Sink Pedestals are not available.

### Single Pedestals with Sink

Overall dimensions of sink are 19"D x 15"W. Inside dimensions of sink are 16"D x 11 1/2"W with a 7 1/2" Deep sink. Drain opening is 3 1/2". Sink bowl is 18 gauge, type 302 stainless steel. Sink unit includes a tubular steel support frame, cup sink, tailpiece and hot and cold mixing swivel faucet. Plumbing required. Pedestal front consists of (1) 19 3/4"H door.

Height	Width	Door Type	Product Number	Approx. Weight
34"	15"	Left Hand	TK-525L_	110
		Right Hand	TK-525R_	110

Specify color preference with a suffix to the product number:  
 \*Worksurface Colors: D - Natural Almond, G - Dove Gray

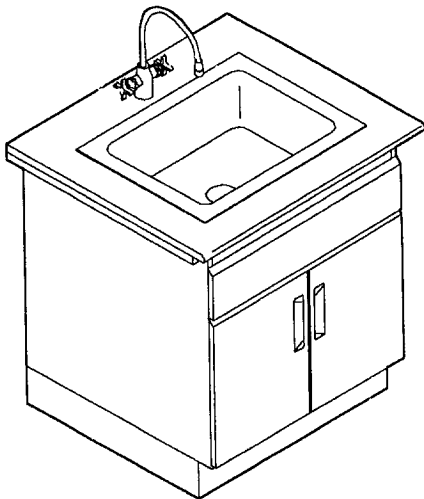

### Double Pedestals with Sink

Overall dimensions of sink are 19 1/2"D x 25"W. Inside dimensions of sink are 15 3/4"D x 21"W with a 7 1/2" Deep sink. Drain opening is 3 1/2". Sink bowl is 18 gauge, type 302 stainless steel. Sink unit includes a tubular steel support frame, cup sink, tailpiece and hot and cold mixing swivel faucet. Plumbing required. Pedestal front consists of (2) 19 3/4"H doors.

Height	Width	Product Number	Approx. Weight
34"	15"	TK-526_	150

Specify color preference with a suffix to the product number:  
 \*Worksurface Colors: D - Natural Almond, G - Dove Gray

# SHELVES

## Front Radius Edge Shelves

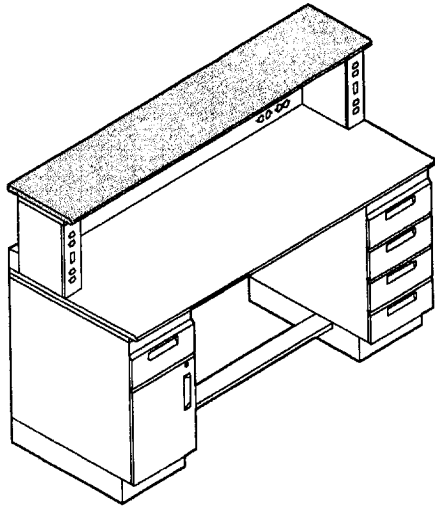

Shelves are composed of high pressure plastic laminate and include a tubular steel support frame.

ESD Shelves are composed of electrostatic dissipative (ESD) plastic laminate. A grounding kit is provided.

Depth	Width	Product Number		Approx. Weight
		Standard*	ESD*	
15"	36"	41536D_	41536DE_	36
	48"	41548D_	41548DE_	43
	60"	41560D_	41560DE_	50
	72"	41572D_	41572DE_	57
	84"	41584D_	41584DE_	64
	96"	41596D_	41596DE_	72
18"	36"	41836D_	41836DE_	37
	48"	41848D_	41848DE_	44
	60"	41860D_	41860DE_	51
	72"	41872D_	41872DE_	59
	84"	41884D_	41884DE_	66
	96"	41896D_	41896DE_	74

Specify color preference with a suffix to the product number:

\*Laminate Colors: F - Natural Almond, FG - Dove Gray

Note: A slight variance in color exists between standard and ESD worksurfaces

## SHELVES - MAPLE

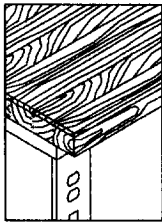

Maple (1 3/4" Thick)

### Maple Shelves

Maple Shelves are constructed of cured maple hardwood and finished with a non-glare, clear lacquer coating. An optional tubular steel frame is available for corner and bridging capabilities.

Depth	Width	Product Number		Approx. Weight
		With Frame	Without Frame	
15"	36"	M1536F	N/A	35
	48"	M1548F	M1548N	47
	60"	M1560F	M1560N	56
	72"	M1572F	M1572N	65
	84"	M1584F	M1584N	75
	96"	M1596F	M1596N	85
18"	36"	M1836F	N/A	41
	48"	M1848F	M1848N	54
	60"	M1860F	M1860N	65
	72"	M1872F	M1872N	75
	84"	M1884F	M1884N	86
	96"	M1896F	M1896N	94

## SHELVES - CORNER

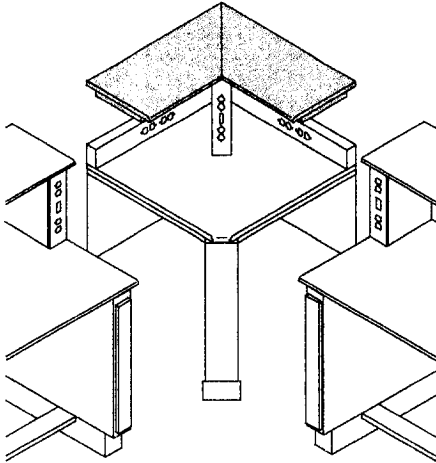

### Front Radius Edge Corner Shelves

A left and right mitered shelf composed of high pressure plastic laminate is provided with a tubular steel support frame. The depth of corner shelves should correspond to the depth of the adjacent workstation shelves.

Adjacent Shelf Depth	Corner Depth	Standard*	ESD*	Approx. Weight
15"	30"	309130_	309230_	43
	36"	309136_	309236_	43
18"	30"	398000_	398004_	52
	36"	398012_	398016_	52

Specify color preference with a suffix to the product number:

\*Laminate Colors: **A** - Natural Almond, **AG** - Dove Gray

Note: A slight variance in color exists between standard and ESD worksurfaces

### Maple Corner Shelves

A left and right mitered shelf constructed of cured maple hardwood is provided with a tubular steel frame. The depth of the corner shelves should correspond to the depth of the adjacent workstation shelves.

Adjacent Shelf Depth	Corner Depth	Product Number	Approx. Weight
15"	30"	309530A	59
	36"	309536A	59
18"	30"	398003A	68
	36"	398015A	68

## SHELF BACKSPASHES

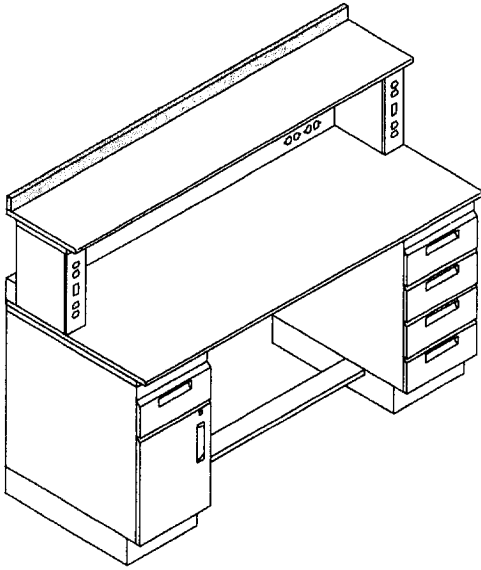

### Shelf Backsplashes

Shelf Backsplashes are 1"D x 2½"H and constructed of 20 gauge steel. ESD Shelf Backsplashes feature dielectric insulation. The width of the shelf backplash must correspond to the width of the workstation shelf.

Width	Product Number		Approx. Weight
	Standard	ESD	
36"	307536	307536E	4
48"	307548	307548E	5
60"	307560	307560E	6
72"	307572	307572E	7
84"	307584	307584E	8
96"	307596	307596E	9

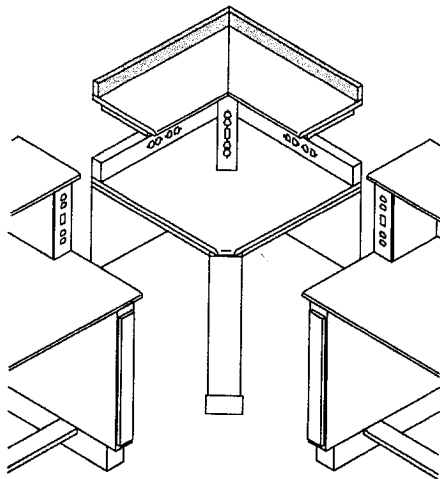

### Corner Shelf Backsplashes

Corner Shelf Backsplashes are 1"D x 2½"H and constructed of 20 gauge steel. ESD Corner Shelf Backsplashes feature dielectric insulation. The width of the Corner Shelf Backsplash must correspond to the width of the corner shelf.

Corner Depth	Product Number		Approx. Weight
	Standard	ESD	
30"	307690	307690E	6
36"	307691	307691E	7

# SHELF RISERS

Shelf Risers feature all steel construction and include grounded receptacles, on/off switch with built-in circuit breaker, and a 10 ft. power cord. All riser heights must be similar in a given workstation.

ESD Shelf Risers feature dielectric insulation. A grounding kit is provided.

### ORDERING GUIDELINES:

48", 60" or 72" width workstations → Specify (2) risers

84" and 96" width workstations → Specify (3) risers

Corner units → Specify (1) riser

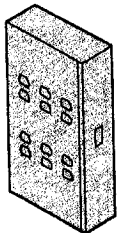
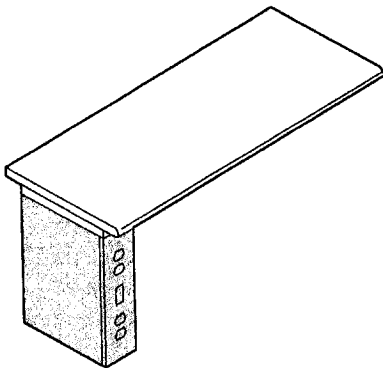
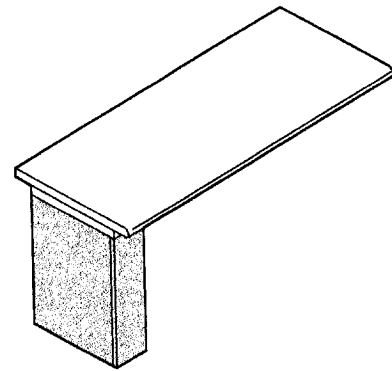

### Shelf Risers

Description	Height	Product No.	Amps	Approx. Weight
Non-Powered	15"	307900	N/A	7
	20"	307901	N/A	9
4 Outlets	15"	307902	15 AMP	9
		307904	20 AMP	9
	20"	307903	15 AMP	11
		307905	20 AMP	11

### ESD Shelf Risers

Description	Height	Product No.	Amps	Approx. Weight
4 Outlets	15"	307902E	15 AMP	9
		307904E	20 AMP	9
	20"	307903E	15 AMP	11
		307905E	20 AMP	11
12 Outlets Left Side	20"	307625LE	15 AMP	13
		307626LE	20 AMP	13
12 Outlets Right Side	20"	307625RE	15 AMP	13
		307626RE	20 AMP	13

## FOOTRESTS

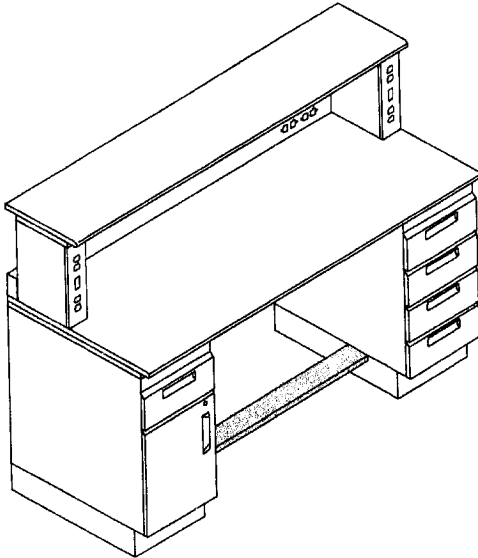

Adjustable steel footrests are painted black. If footrest calculations are less than 25", no footrest is available. A grounding kit is provided with all ESD footrests.

Footrest Length	Product Number		Approx. Weight
	Standard*	ESD*	
25" - 31 $\frac{7}{8}$ "	308026	308026E	8
32" - 41 $\frac{7}{8}$ "	308032	308032E	10
42" - 53 $\frac{7}{8}$ "	308042	308042E	12
54" - 65 $\frac{7}{8}$ "	308054	308054E	14
66" - 78"	308067	308067E	16

### HOW TO SPECIFY FOOTREST:

1. Determine footrest length by calculating available space between pedestals
2. Determine product number by cross-referencing footrest length in table

#### Examples:

##### Left footrest:

$48" - (4" + 15") = 29"$  length  
Specify footrest 308026 or 308026E

##### Right footrest:

$72" - 29\frac{1}{8}" = 42\frac{7}{8}"$  length  
Specify footrest 308042 or 308042E

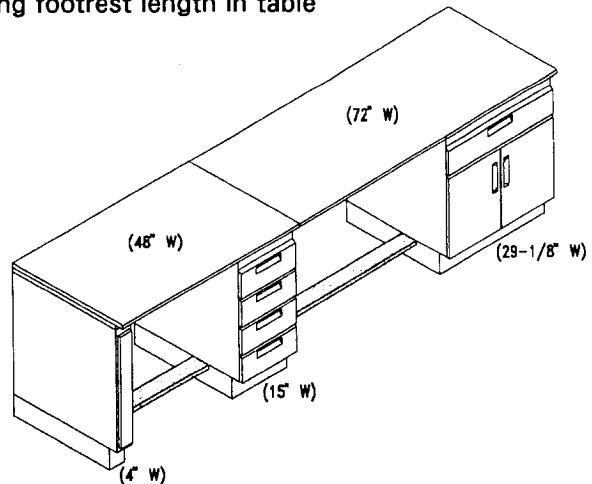

##### Left footrest:

$(96" \div 2) - (15" + \frac{1}{2} \text{ of } 4") = 31"$  length  
Specify footrest 308026 or 308026E

##### Right footrest:

$(96" \div 2) - (15" + \frac{1}{2} \text{ of } 4") = 31"$  length  
Specify footrest 308026 or 308026E

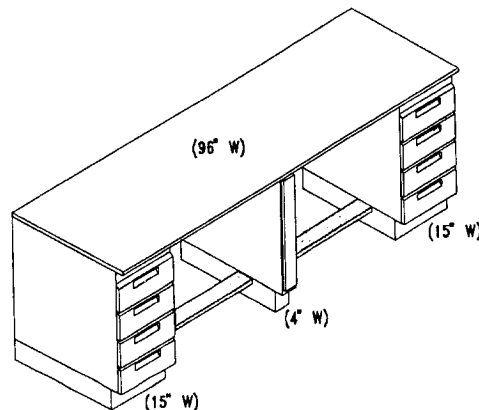

# LIGHTING

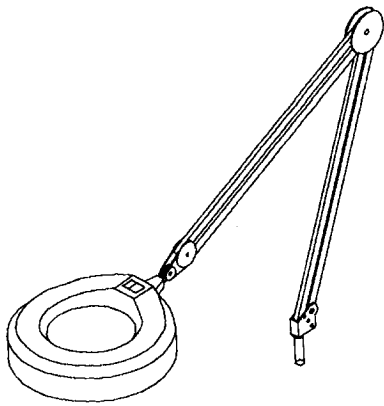

## Magnifier Light

A large 5" diameter, 3-diopter double convex precision ground lens produces distortion-free magnification under bright fluorescent illumination. The steel arm with a 42" reach offers three-way adjustment for greater flexibility in squaring magnifier with viewing area. Available in black.

Product Number	Approx. Weight
980194	9

## Task Lights

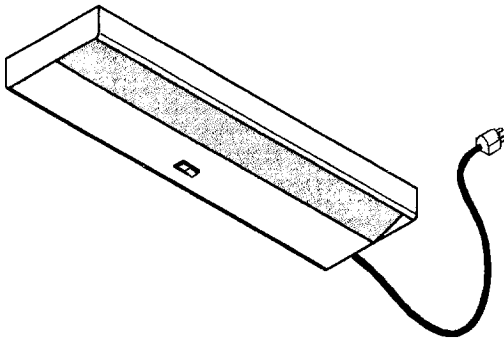

Task Lights mount under the shelf and include a single fluorescent tube, lens cover, 9 ft. cord and on/off switch. Available in black.

Width	Height	Depth	Product Number	Approx. Weight
22"	7"	2"	980190K	8
36"	7"	2"	980191K	9
48"	7"	2"	980192K	10

Specify color preference with a suffix to the product number:

## ESD OPTIONS

---

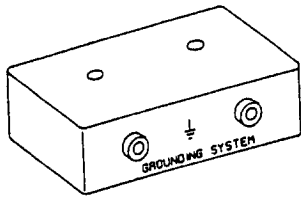

The Wrist Strap Grounding System provides connection of (2) wrist straps by means of banana jacks to the common point to ground.

Description	Product Number	Approx. Weight
Wrist Strap Grounding Kit	990519	1

The Wrist Strap ensures all-around skin contact and electrical conductivity. Includes 5 ft. coiled cord.

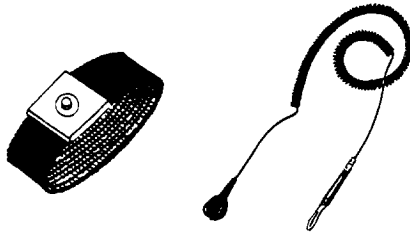

Description	Product Number	Approx. Weight
Wrist Strap	990517	1

## **GENERAL ORDERING INFORMATION**

---

### **Pricing, Terms, and Conditions**

Net 30 days with established credit.

All prices are F.O.B. Factory and are subject to change without notice. Due to our continual research and development, changes may occur in product specifications. We reserve the right at any time to alter design and to substitute materials and parts to supply the article which is our standard at time of shipment.

Remit all payments to Kewaunee Scientific Corporation, Technical Products Division, 901 FM 20, P.O. Box 930, Lockhart, Texas 78644. No state or local sales tax, or any other tax that may be levied or assessed upon a sale or purchase of products listed in this ordering guide is included in prices quoted. Any such taxes must be paid by the purchaser, and if, by law, the vendor is chargeable with the collection or payment thereof, the sum must be added as tax to the prices quoted.

### **Order Confirmation**

All orders are acknowledged upon receipt. It is the customer's responsibility to see that the items shown conform to those ordered, and if any discrepancy exists, to notify a Kewaunee Scientific representative immediately. The order acknowledgement is the final agreement between the customer and Kewaunee Scientific Corporation and supersedes all prior documents and may not be modified except by a revised purchase order.

### **Shipping**

All shipments are made "best way" (motor freight, common carrier, UPS) unless otherwise requested in writing. Kewaunee is not responsible for delay in shipment caused by conditions beyond our control. All weights shown are approximate and obtained from standard packaging procedures.

### **Damage in Transit**

Customer should inspect shipment upon receipt. All loss or damage claims must be made against the carrier. No claims for damage may be deducted from invoices.

### **Returns**

Returned merchandise will not be accepted unless first authorized by Kewaunee Scientific Corporation. A 20% restocking charge, plus repair and rehabilitation, and any freight charges incurred will be applied to any return shipment. The customer will be billed for any damaged goods not collectible from the carrier. Return shipments must be prepaid and returned via same delivering carrier(s).

### **Colors**

Standard paint colors for FlexTech Technical Workstations are Sand Tan, Flint Gray, White and Black. Customized colors are available upon request. Consult your Kewaunee Customer Service Representative for details.

### **Assembly**

Some assembly is required. Instruction manuals will accompany all orders.

### **Specifications**

A complete set of product specifications is available upon request. All dimension listed are nominal.

### **Special Product Requests**

If quantities or circumstances warrant, we will be pleased to quote pricing on custom products. Send drawings and specifications Attn: Kewaunee Customer Service Department. Lead time will normally increase and custom orders are noncancellable.

### **How to Order**

Purchase Orders are to be made out to Kewaunee Scientific Corporation, Technical Products Group. The mailing address is as follows:

**Ordering Department  
Kewaunee Scientific Corporation  
901 FM 20, P.O. Box 930  
Lockhart, Texas 78644**

**CALL TOLL FREE 800/824/6626**

---



How to Order

Purchase orders are to be made to Kewaunee Scientific Corporation. The mailing address is:

**Ordering Department**  
**Kewaunee Scientific Corporation**  
**901 FM 20, P.O. Box 930**  
**Lockhart, Texas 78644**  
**Fax No. 800/624/5536**

E-MAIL ADDRESS: [custsvc@kewaunee-tpg.com](mailto:custsvc@kewaunee-tpg.com)

For information concerning your orders, contact the Kewaunee Customer Service Department:  
Toll free: 1/800/824/6626.